

1. GENERAL INFORMATION

1.1 Scope of this leaflet

Congratulations on your purchase of a Sturmey-Archer internal gear hub. For the best performance, please follow instructions in this leaflet. Please contact your dealer if any problems are experienced with these products.

△Riding the gear hub out of the adjustment may cause damage to the internal parts and possible malfunction !

1.2 Lubrication

No routine lubrication is required. During a major service, the hub greases should be replenished or replaced especially for transmission parts of the internal hub gear. Please contact your Sturmey-Archer dealer who is equipped to carry this out.

△Under no circumstances should any lubricant be applied to the brake drum and brake shoes, as this may prevent the brake from functioning!

1.3 Gear Changing

Continue pedaling, but ease pressure on the pedals and select the gear required. If the bicycle is stationary simply select gear required.

1.4 Gear Ratio

1st Gear 0.75 | 2nd Gear 1.0 | 3rd Gear 1.33

1.5 Brake Operation

To activate the brake, pull the appropriate brake lever on the handlebar. If the wheel does not run free, or cannot be locked by a full application of the brake, then adjustment is necessary.

2. INSTALLATION

1. Build the hub into wheel.
2. Assemble the sprocket (3) and circlip (2).

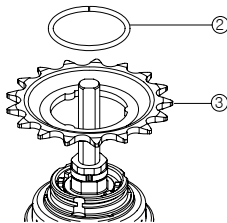

3. Fit fulcrum lever set (4) on the hub.

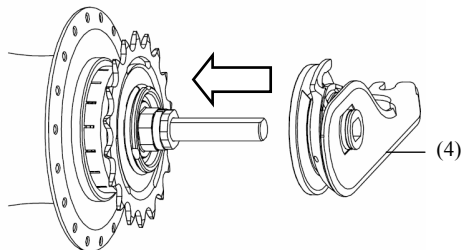

4. Check the position of the protrusions of the shift actuator. They should align with the guide hole of cable pulley when the fulcrum lever set is fitted on the axle.

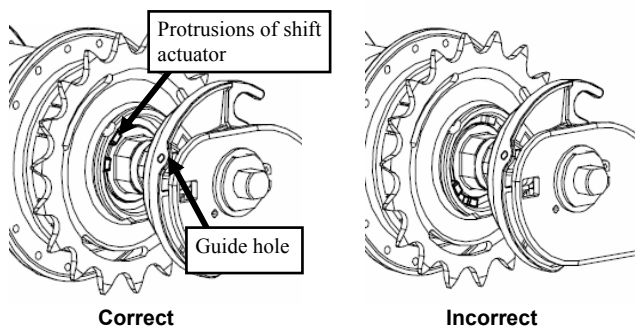

5. If the shift actuator is not in the correct position and the protrusion does not align with the guide hole of the fulcrum lever, rotate the shift actuator clockwise to the correct position using a screwdriver or the fulcrum lever..

Note: If the shift actuator is jammed and cannot be rotated into the correct position, turn the driver clockwise to release it.

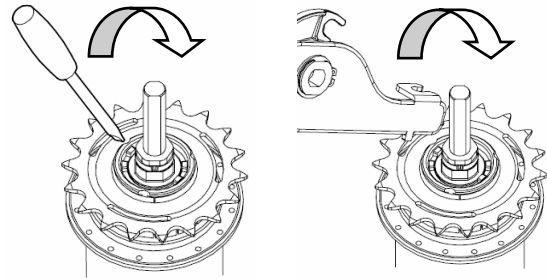

6. Make sure the protrusions of shift actuator engage with the cable pulley correctly.

Note: A specific fulcrum lever set is required for each type of rear dropout.

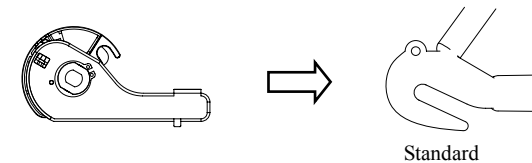
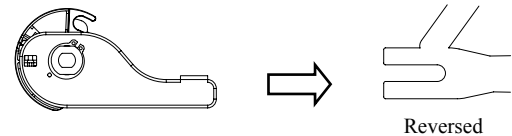

7. Fit the nut onto the axle to fix the fulcrum lever set. (The thickness of nut is 3.2mm, and the tightening torque is **6.5-8.5Nm**.)

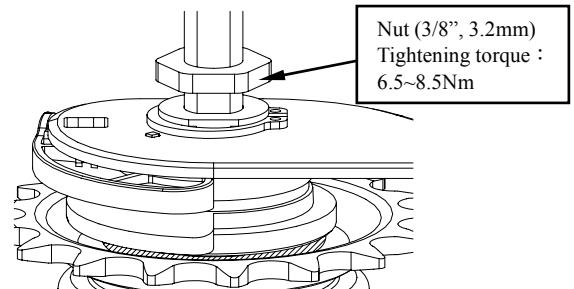

8. Place the wheel into frame and place the chain around the sprocket. Fit the lock-washer (5), dome-nut (6) on the right side of the axle. **Screw the nut finger tight.**

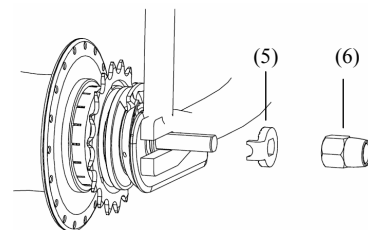

9. **For RX-RF3, RX-RK3, RX-RB3**
Fit the lock-washer (5) and dome-nut (6) on the left side of the axle.

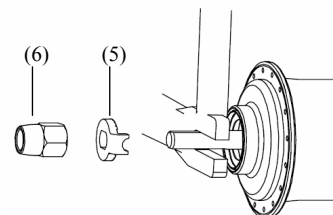

For RX-RD3, RXL-RD3

Fit the brake arm into brake clip (11) with nut (11A) and bolt (11B). **Do not tighten at this point.**

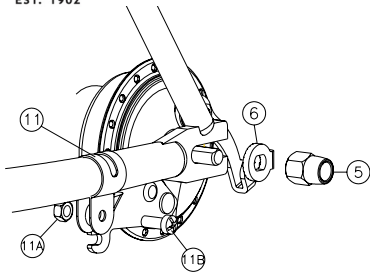

10. Make sure that fulcrum lever does not interfere with chain-stay.

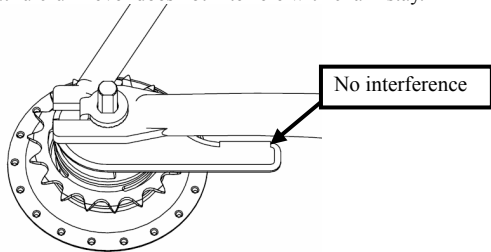

11. Align the wheel and tension the chain. Tighten the axle-nut to **28Nm** and tighten the brake arm clip bolt/nut to **7Nm**.
12. Make sure the shifter is in 3rd gear position.
13. Slide the cable adjuster guide onto the fulcrum lever.

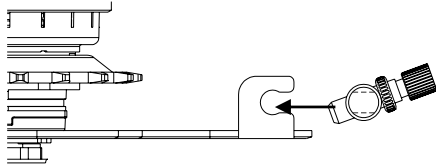

14. Fix the cable with the cable anchor unit. Set a proper distance as shown, and then tighten the cable anchor nut to **3 Nm**.

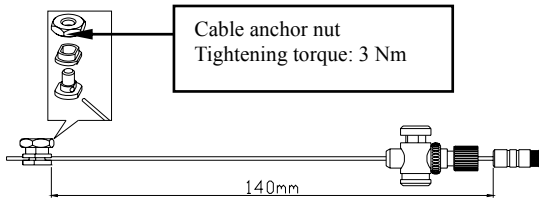

15. Insert a 2mm diameter rod into the guide hole and turn the fulcrum lever pulley counter-clockwise. Take the shifter cable and loop the cable underneath and around the fulcrum lever pulley and fix the cable bolt into position with the cable anchor nut face out. Then remove the rod.

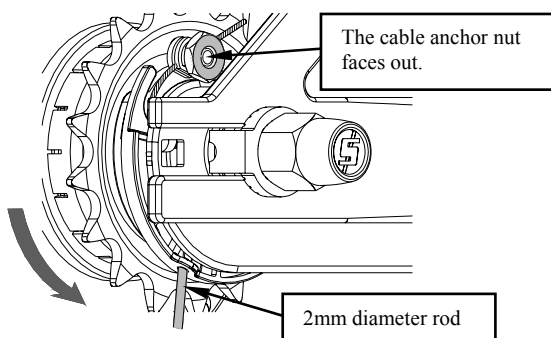

3. GEAR ADJUSTMENT

1. Turn Shifter to position "2".
2. Adjust the adjuster until the yellow guide arrow on the fulcrum lever pulley is in the center of the two guide lines as shown below.

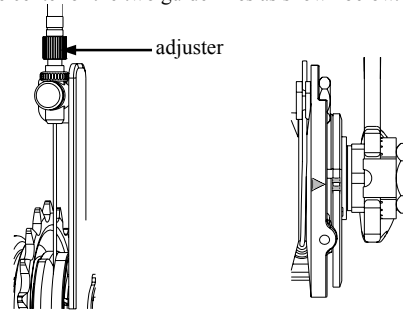

4. DRUM BRAKE INSTALLATION AND ADJUSTMENT

4.1 RX-RD3, RXL-RD3

1. Locate the brake cable adjuster bolt (23) into brake arm. Rotate the brake lever and then put the brake cable nipple (24) into the brake lever.
2. Slacken the brake adjuster locknut (25).
3. Turn the adjuster (26) counterclockwise until the brake is just applied.
4. Turn the adjuster clockwise (about four revolutions) until the wheel just spins freely.
5. Tighten the locknut (25).

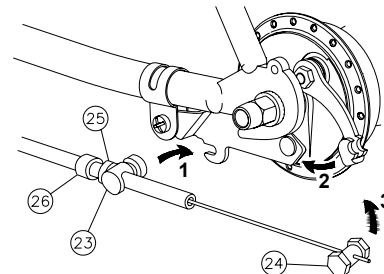

△The brake adjustment must be checked or replaced if necessary before first using the bicycle, and after removing or replacing the wheel.

Note : During the first few miles, brake linings "bed-in" and may then require re-adjustment. Should braking efficiency become impaired beyond adjustment, brake shoes and linings may need replacement. Contact your SturmeY-Archer dealer who is equipped to replace these.

4.2 RS-RF3, RS-RK3, RS-RB3

Check and adjust other brake types according to brake manufacturers manual.